



Summary

DARC-II is a standalone Data Acquisition and Remote Control (DARC) module. It is controlled by a remote device running FlexiPanel Client software using the Bluetooth link. No development on the remote device is required.

Hardware Features

- FCC / CE / IC certified Class I Bluetooth V1.1 radio, 100m range, integral antenna.
- 12 analog inputs (10-bit).
- 5 PWM outputs (10-bit).
- 7 digital dedicated digital I/O pins.
- All analog and PWM pins may be also configured for digital I/O.
- Digital I/O pins can be configured as one 7-bit and/or up to two 5-bit parallel digital I/O.
- 64K flash, 2.3K RAM and 1K EEPROM memory available on-board.
- Up to 256K I2C external memory.
- Real time clock.
- Onboard power regulator, 5V – 10V supply.

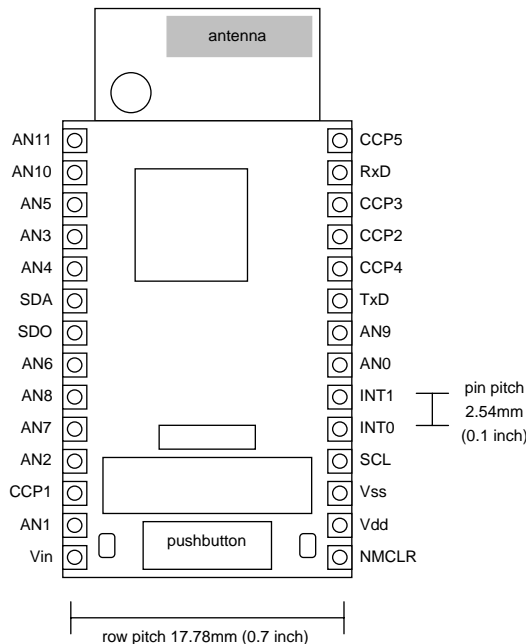

phone and module not to scale

Firmware Features

DARC-II has an on-board FlexiPanel Server to create user interfaces on remote devices. The user interface and I/O configuration are programmed wirelessly using FlexiPanel Designer software. The I/O pins are linked to controls, e.g.:

- *Text control driven by digital input* – has separate text strings for 'low' and 'high'.
- *Number control driven by analog / parallel input* – equals analog value / parallel data.
- *Date-time chart driven by analog / parallel input* – appends time-stamped value onto chart.
- *Digital output driven by button / image* – pulses high for 50ms when pressed.
- *Digital output driven by latch* – on or off according to state of the latch.
- *Parallel output driven by number / list control* – parallel data represents number / selection.
- *PWM output driven by number / list control* – duty cycle represents number / selection.

Customization

- Firmware C source code and customization services available.

Manufactured to ISO9001:2000



Ordering Information

Part No	Description
	DARC-II 28-pin Dual-in-Line package Evaluation Version
	DARC-II 28-pin Dual-in-Line package – Custom firmware xxx

Pin Descriptions

Pin Names	Description
AN0-AN11	Analog input or digital I/O (see note 2)
CCP1-CCP5	PWM output or digital I/O (see note 2)
SDA, SCL	External memory interface or digital I/O (see note 2)
SDO, TxD, RxD, INT0, INT1	Digital I/O (see note 2)
NMCLR	50ms pulse low to reset. May be left unconnected.
Vdd	Regulated power +5V (see note 1,2)
Vin	Unregulated power input +5 to +10V (see note 1)
Vss	Power ground reference

1. Either (i) regulated power should be provided on Vdd and Vin left unconnected or (ii) unregulated power should be provided on Vin and Vdd may be used as a regulated power output.
2. If on-board power regulator used, total current draw on all outputs (including Vdd if used as a regulated power output) shall not exceed 130mA.

Initializing the Evaluation Application

DARC-II is based upon the ToothPIC module from FlexiPanel Ltd. The Evaluation Version is intended for OEMs to use to evaluate the technology prior to customizing to their product lines.

The DARC-II Evaluation Version is supplied as a ToothPIC module which must be 'Field Programmed'. This takes a few seconds and requires either a Windows PC or a Pocket PC with Bluetooth. This is not necessary for customized firmware versions. The procedure is as follows. If required use the default PIN code "0000".

1. Download the ToothPIC Development Kit from www.flexipanel.com and locate the DARC-II Service Pack Darc-II Win.exe (Windows) or Darc-II PPC.exe (Pocket PC).
2. Power-up the ToothPIC with the on-board pushbutton held down. The on-board LEDs will flash simultaneously.
3. Start running the DARC-II Service Pack and connect from the computer to the ToothPIC using Bluetooth.
4. Enter the COM port used to connect to the ToothPIC in the box provided.
5. Press the Update button. Programming takes about 30 seconds. When the progress bar is full, field programming is complete.

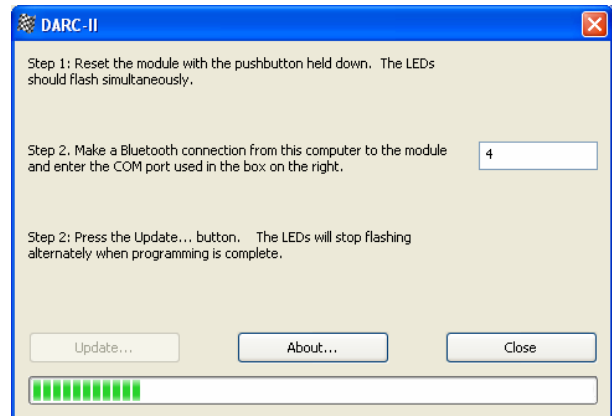

When first loaded, the I/O and the user interface are in a harmless configuration. To connect to DARC-II from a remote device:

6. If you have not already done so, go to www.FlexiPanel.com and download FlexiPanel Client software for Windows, Pocket PC, Smartphone or Java phone. Install as required.
7. Check the green LED on ToothPIC is flashing regularly. This indicates the application is operating correctly.
8. Connect to ToothPIC from the FlexiPanel Client as described in the instructions for the client. The red LED will come on when the connection is made and the user interface, composed only of the words 'DARC-II', will appear. Press Close to disconnect from DARC-II.

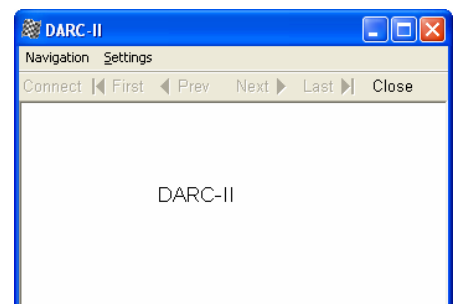

- A more interesting user interface will now be programmed into DARC-II and the I/O configured. If you have not already done so, download from www.FlexiPanel.com (i) the FlexiPanel Designer software and (ii) the configuration file `DARCIITestRes.FxP`. Open `DARCIITestRes.FxP` from within the Designer software. In the main screen is a list of the controls in the user interface.

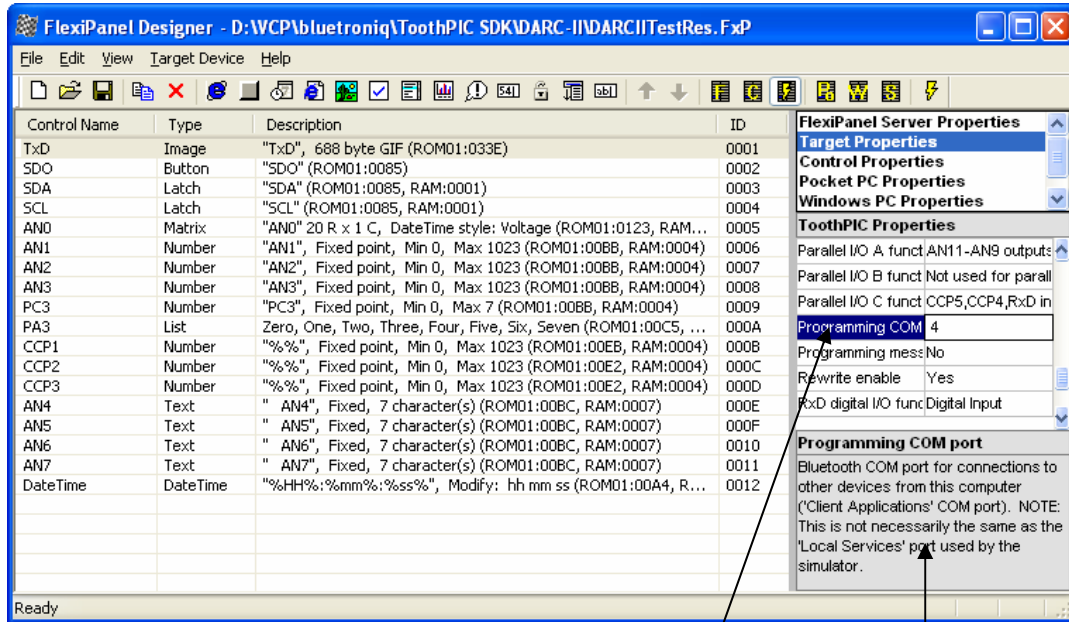

Programming COM Port property Helpful hints

- Power-up the module with the pushbutton pressed down. The LEDs will flash rapidly, indicating that it is allowing itself to be configured. Connect to the module from your Windows PC and make a note of the COM port that Bluetooth uses. In FlexiPanel Designer menu, select `View > DARC-II Properties` and, in the properties list on the right, find the property 'Programming COM Port' and set the value to the COM port Bluetooth is using. Select `Target Device > Program DARC-II` from the menu. The user interface and I/O will be programmed into the DARC-II. When programming is complete, the green LED will begin to flash slowly.

- Connect to ToothPIC from the FlexiPanel Client again. This time the user interface will be more detailed:

State of digital inputs AN4 – AN7. (in eval, blank = low)

Analog input AN0 logged every 2 secs. Click to zoom in.

Analog inputs AN1 to AN3 depicted as progress bars.

Parallel input CCP5, CCP4, RxD.

Set the duty cycle of outputs CCP1, CCP2 and CCP3

Set digital outputs TxD, SDO, SCL and SDA using image, button and latch controls

Set parallel digital outputs AN11, AN10 and AN9 using the list control

Set the clock.

- Adjust the modifiable controls and monitor the consequent changes on the output pins. Set the values of the input pins and observe the consequent changes in the user interface. (Since the input pins are floating you can just tough them to change their voltages.)

User Interface and I/O Design

The Evaluation Application shows many of the capabilities of the DARC-II module but is unlikely to apply directly to your needs. The FlexiPanel Designer software may be used to customize the user interface and I/O. This is documented in full in the documentation for FlexiPanel Designer. The following tutorial shows how the Evaluation Application configuration file `DARCIITestRes.Fxp` design was created. Close and re-open FlexiPanel Designer and follow these steps:

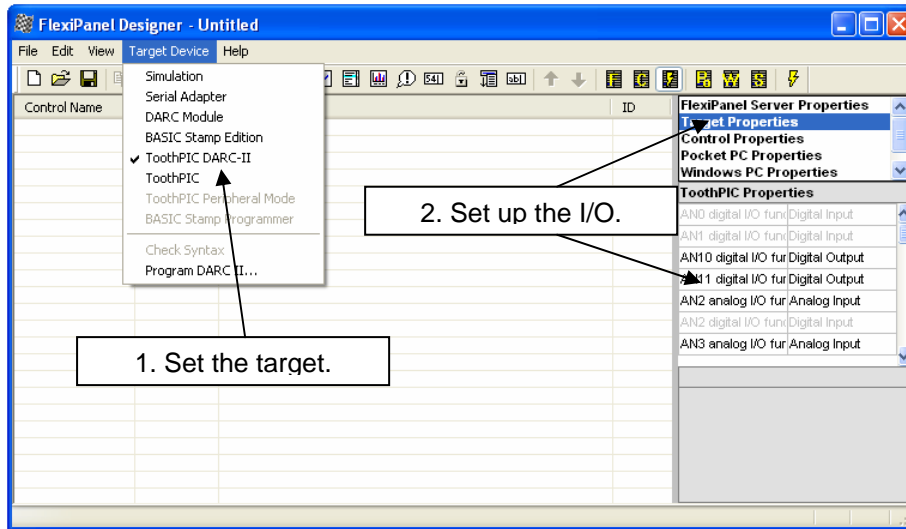

- Select *Target Device > ToothPIC DARC-II* from the menu.
- From the Target Properties list on the right, set the following I/O properties, in the order specified:

Property	Value	Meaning
Analog inputs	A0-A3	Sets A0 – A3 as analog inputs.
AN10 digital I/O function	Digital Output	Sets AN10 as a digital output.
AN11 digital I/O function	Digital Output	Sets AN11 as a digital output.
AN2 analog I/O function	Digital Input	Sets AN2 as an analog input.
AN3 analog I/O function	Digital Input	Sets AN3 as an analog input.
AN4 digital I/O function	Digital Input	Sets AN4 as a digital input.
AN5 digital I/O function	Digital Input	Sets AN5 as a digital input.
AN6 digital I/O function	Digital Input	Sets AN6 as a digital input.
AN7 digital I/O function	Digital Input	Sets AN7 as a digital input.
AN8 digital I/O function	Digital Input	Sets AN8 as a digital input.
AN9 digital I/O function	Digital Output	Sets AN9 as a digital output.
CCP1 digital I/O function	PWM Output	Sets CCP1 as a PWM output.
CCP2 digital I/O function	PWM Output	Sets CCP2 as a PWM output.
CCP3 digital I/O function	PWM Output	Sets CCP3 as a PWM output
CCP4 digital I/O function	Digital Input	Sets CCP4 as a digital input.
CCP5 digital I/O function	Digital Input	Sets CCP5 as a digital input.
INT0 digital I/O function	Digital Input	Sets INT0 as a digital input.
INT1 digital I/O function	Digital Input	Sets INT1 as a digital input
Input refresh rate	2s	Inputs will be re-scanned every two seconds.
On Error...	Flash Error Number	On error, display error number on LEDs before resetting by press of the pushbutton.

Property	Value	Meaning
PWM base time units	3.2us	Sets the base time unit of the PWM outputs to be 3.2 microseconds.
PWM Period	256	PWM period is 256 base time units = 1221Hz.
Parallel I/O A function	AN11 – AN9 outputs	AN11 – AN9 constitute a 3-bit parallel binary output value.
Parallel I/O B function	Not used for parallel	Parallel B pins perform other tasks.
Parallel I/O C function	CCP5, CCP4, RxD outputs	CCP5, CCP4, RxD constitute a 3-bit parallel binary input value.
Programming COM port	As required	The COM port the computer running Designer uses for outgoing connections.
RxD digital I/O function	Digital Input	Sets RxD as a digital input.
SCL digital I/O function	Digital Output	Sets SCL as a digital output.
SDA digital I/O function	Digital Output	Sets SDA as a digital output.
SDO digital I/O function	Digital Output	Sets SDO as a digital output.
TxD digital I/O function	Digital Output	Sets TxD as a digital output.

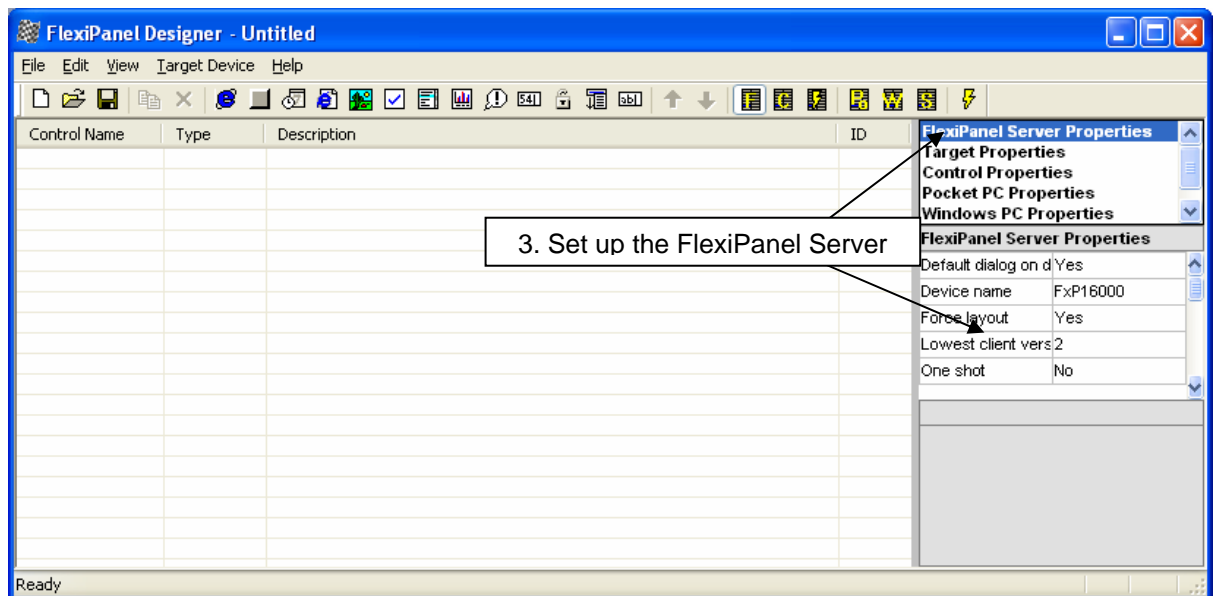

- From the list box at the top of the properties list on the right, select *FlexiPanel Server Properties*. In the properties list box, set the following server properties:

Property	Value	Meaning
Device Name	DARC-II Test	Sets the device name to 'DARC-II Test'.
Force Layout	Yes	Ensures control layout is reloaded each time.
Ping Client	No	Turns off client pings. NOTE: This is required from version 3.0.00002 to avoid a known bug.

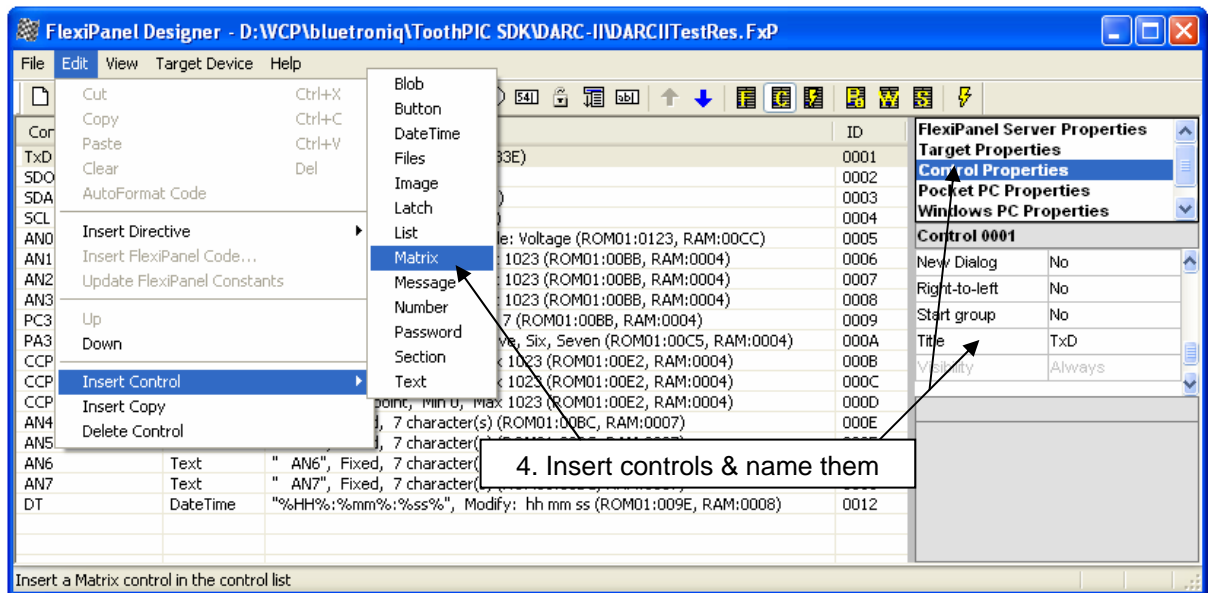

- From the list box at the top of the properties list on the right, select *Control Properties*. From the *Insert > Insert Control* menu, insert the following controls and then immediately set the titles in the properties list on the right as follows:

Control Type	Title	Meaning
Image	TxD	Creates an image control with the name TxD
Button	SDO	Creates a button control with the name SDO
Latch	SDA	Creates a latching button with the name SDA
Latch	SCL	Creates a latching button with the name SCL
Matrix	AN0	Creates a matrix control with the name AN0.
Number	AN1	Creates a number control with the name AN1.
Number	AN2	Creates a number control with the name AN2.
Number	AN3	Creates a number control with the name AN3.
Number	PC3	Creates a number control with the name PC3.
List	PA3	Creates a list control with the name PA3.
Number	CCP1	Creates a number control with the name CCP1.
Number	CCP2	Creates a number control with the name CCP2.
Number	CCP3	Creates a number control with the name CCP3.
Text	AN4	Creates a text control with the name AN4.
Text	AN5	Creates a text control with the name AN5.
Text	AN6	Creates a text control with the name AN6.
Text	AN7	Creates a text control with the name AN7.
DateTime	DT	Creates a date-time control with the name DT.

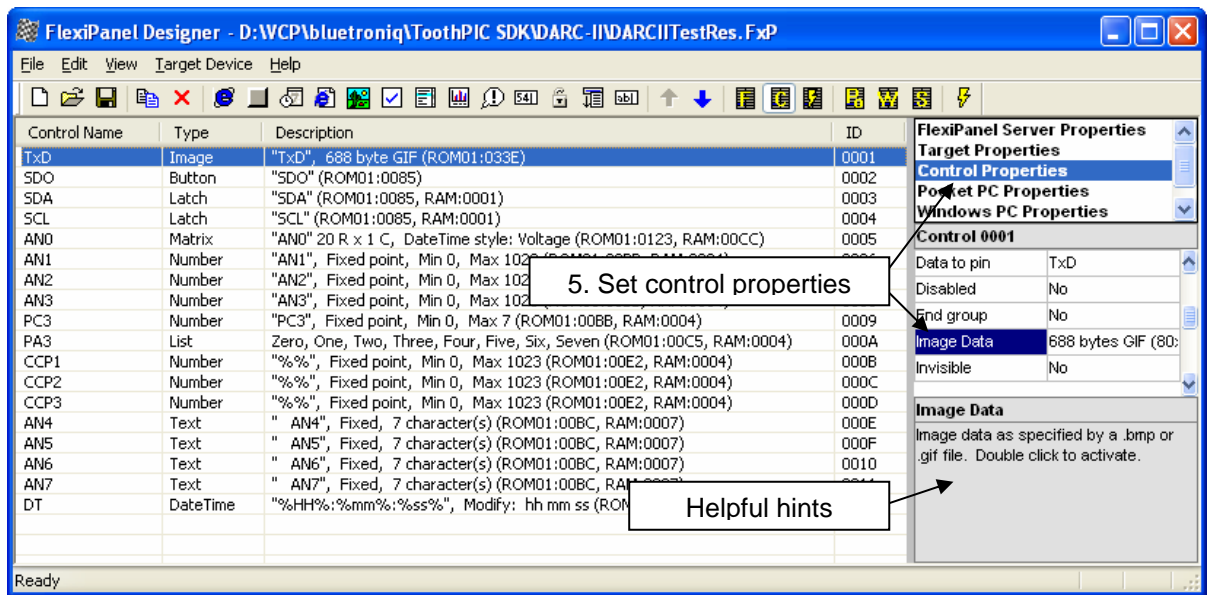

5. In the control list that occupies the main part of the screen, click on the controls and set their properties as follows, in the order specified:

Control - Property	Value	Meaning
TxD – Data to pin	TxD	Pulses the TxD pin high when the image is clicked
TxD – Image data	Any GIF file	Sets the source data for the GIF image
SDO – Data to pin	SDO	Pulses the SDO pin high when the button is pressed.
SDA – Data to pin	SDA	Set the SDA pin according to the state of the latch.
SCL – Data to pin	SCL	Set the SCL pin according to the state of the latch.
AN0 – X-Axis type	DateTime	Specifies the X axis will be date-time values.
AN0 – Cell storage	2-byte	Specifies that the matrix cell values are 2-byte signed integers..
AN0 – Column titles	Voltage	The Y axis name is 'Voltage'.
AN0 – Data from pin	AN0	Appends the analog voltage on AN0 to the chart every input refresh cycle.
AN0 – Max rows	20	Chart remembers the last 20 rows of data
AN0 – Row title	AN0 value	The X axis name is 'AN0 value'..
AN1 – Color	Requested	Specified a color preference.
AN1 – Color B / G / R	0 / 0 / 255	Specifies RGB value 254-0-0 (red). Note – control background changes from white to black if R+G+B>254.
AN1 – Data to/from pin	AN1	Sets the control value to the voltage on AN1.
AN1 – Format string	AN1	The control text is AN1 rather than the actual value
AN1 – Maximum limit	Yes	There is a maximum value for this number
AN1 – Maximum value	1023	The maximum value is 1023
AN1 – Minimum limit	Yes	There is a minimum value for this number
AN1 – Minimum value	1023	The minimum value is 1023
AN2 & AN3 – as AN1 but different colors / data from pin / format string as appropriate		
PC3 – as AN2 & AN3 but data from pin is 'Parallel C' and maximum value is '7'		
PA3 – Data to pin	Parallel A	Sets parallel output pins A11, A10 and A9 to the list selection value.
PA3 – List items	Zero;One;Two;Three;Four;Five;Six;Seven	Sets the list box contents to the words 'Zero' to 'Seven'
CCP1 – Data to/from	CCP1	Sets the CCP1 PWM output duty cycle equal to the

Control - Property	Value	Meaning
pin		control value.
CCP1 – Maximum limit	Yes	There is a maximum value for this number
CCP1 – Maximum value	1023	The maximum value is 1023
CCP1 – Minimum limit	Yes	There is a minimum value for this number
CCP1 – Minimum value	1023	The minimum value is 1023
CCP2 & CCP3 – as CCP1.		
AN4 – Data storage	RAM	The text value should be stored in RAM memory.
AN4 – Data from pin	AN4	The text value should be stored in RAM memory.
AN4 – Initial text	. . .AN4 where . means a space	DARC-II will display the first half of the initial text (spaces) when AN4 is low and the second half (AN4) when the input is high.
AN4 – Maximum length	7	Sets the initial text length to exactly 6 characters plus a zero terminator. Without this, the DARC-II doesn't know where to cut the string in half.
DT – Modifiable	Yes	Allows the date time control to be modified by the user
DT – Modifiable hours	Yes	Allows the hours to be modified
DT – Modifiable mins	Yes	Allows the minutes to be modified
DT – Modifiable secs	Yes	Allows the seconds to be modified

- From the list box at the top of the properties list on the right, select *Pocket PC Properties*. The screen changes to show the layout of the controls on Pocket PC. Drag and drop the controls as shown in the following graphic. To move a control, drag its + sign. To size it, drag its arrow sign.

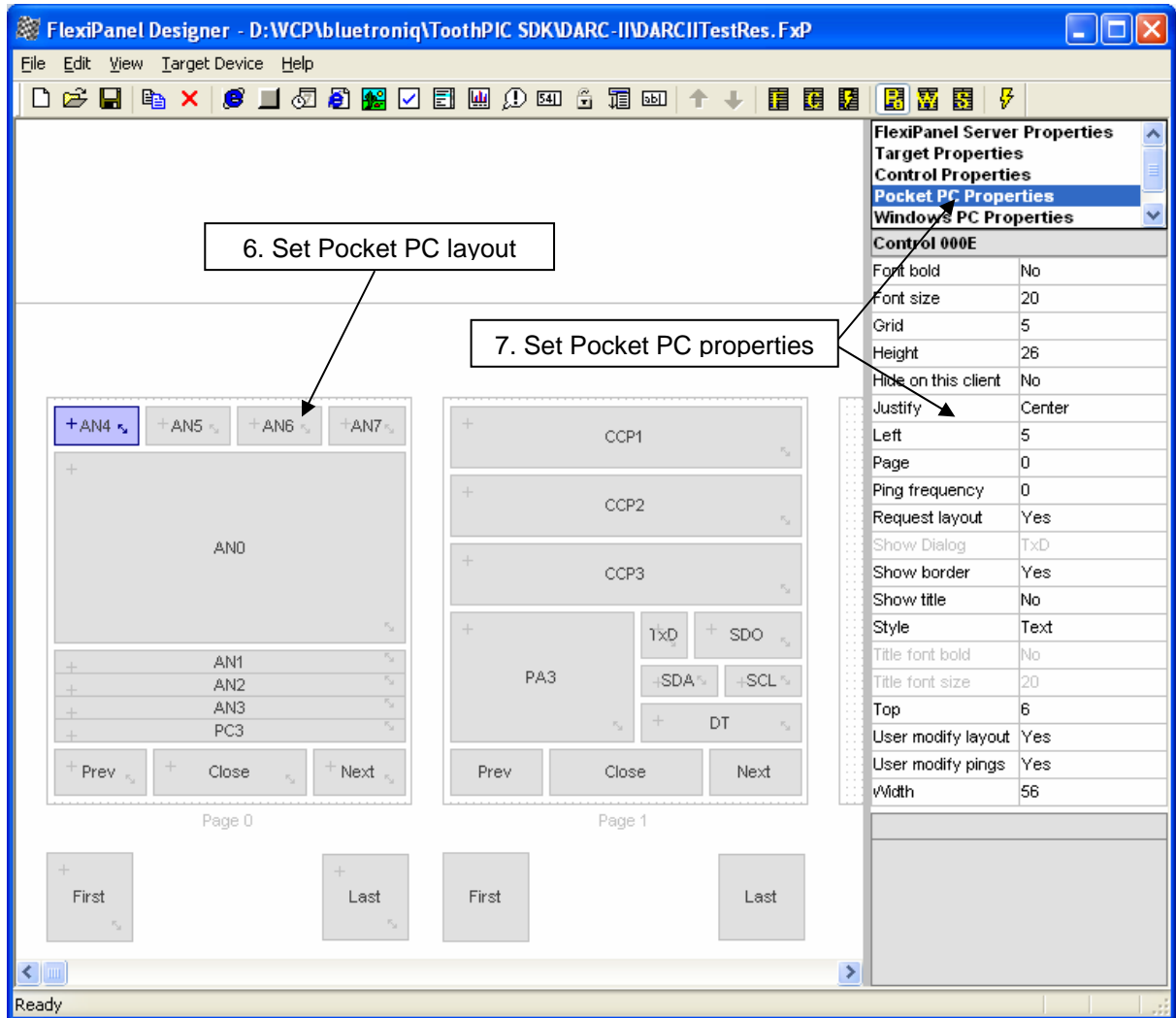

- Click on the controls that appear in the main part of the screen and set their properties as follows, in the order specified:

Control - Property	Value	Meaning
AN4 – Justify	Center	Centers the text in the control
AN4 – Show border	Yes	Requests a line border
AN5, AN6 & AN7 – As AN4.		
AN0 – Axis limits	Yes	Allows the Y axis limits to be specified
AN0 – Show border	Yes	Requests a line border
AN0 – Y Axis max	1023	Sets the top of the Y axis to 1023
AN0 – Y Axis min	0	Sets the bottom of the Y axis to 0
AN1 – Font size	13	Sets the text font size to 13
AN1 – Style	Progress bar	Sets the control appearance to a progress bar
AN2, AN3 & PC3 – As AN1.		
CCP1 – Title front size	14	Sets the title text size to 14
CCP1 – Show title	Yes	Shows the control title 'CCP1' next to the control
CCP1 – Style	Slider	Requests a slider control
CCP2 & CCP3 – As CCP1.		

Control - Property	Value	Meaning
PA3 – Style	Regular list	Sets the control style as a list box (as opposed to a drop-down list box)
DT – Style	Inline control(s)	Sets the control to be a date-time picker control

8. From the list box at the top of the properties list on the right, select *Windows Properties*. The screen changes to show the layout of the controls on a Windows client. Drag and drop the controls as shown in the following graphic. To move a control, drag its + sign. To size it, drag its arrow sign.

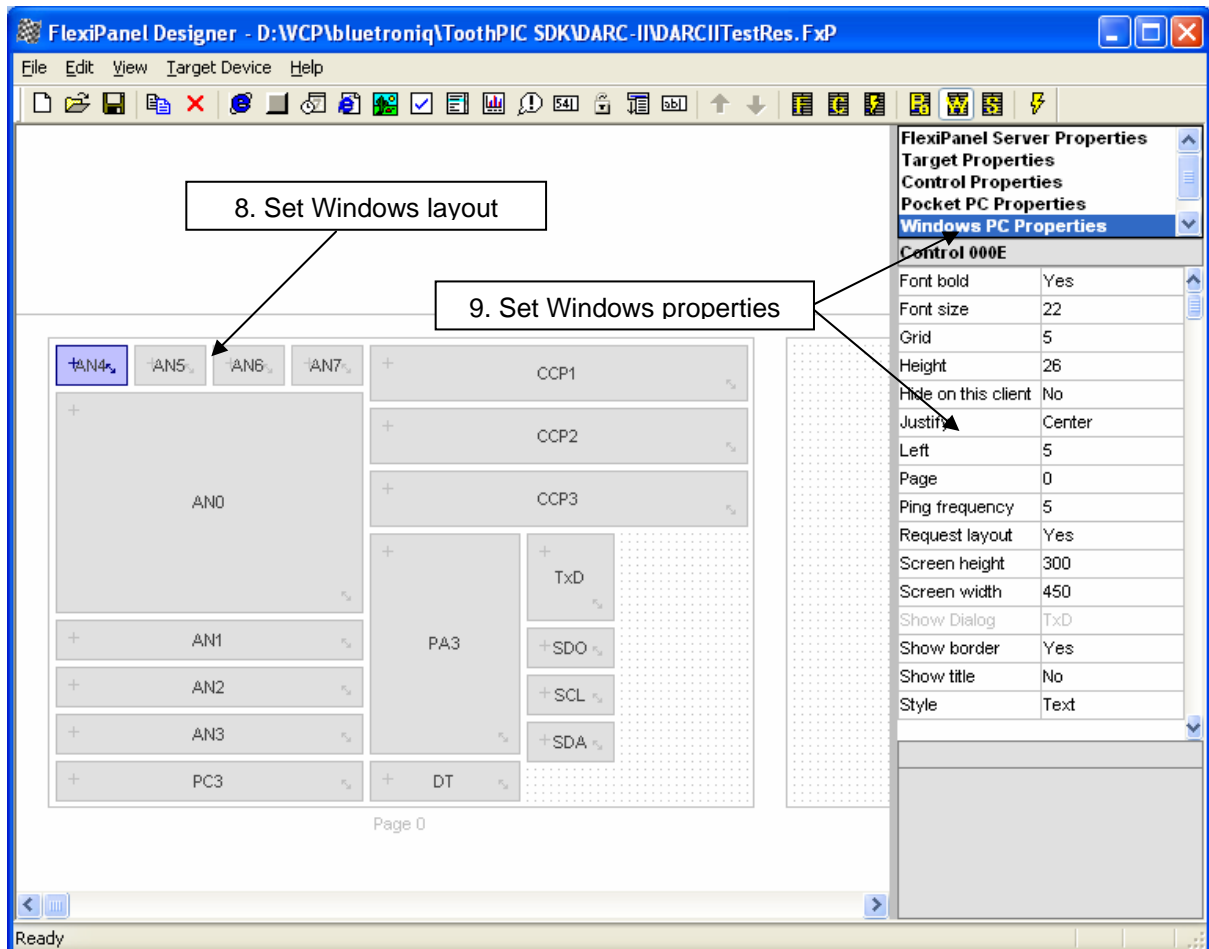

9. Click on the controls that appear in the main part of the screen and set their properties as follows, in the order specified:

Control - Property	Value	Meaning
AN4 – Font bold	Yes	Sets the text font to bold
AN4 – Font size	22	Sets the text font size 22
AN4 – Justify	Center	Centers the text in the control
AN4 – Show border	Yes	Requests a line border
AN5, AN6 & AN7 – As AN4.		
AN0 – Axis limits	Yes	Allows the Y axis limits to be specified
AN0 – Show border	Yes	Requests a line border
AN0 – Y Axis max	1023	Sets the top of the Y axis to 1023
AN0 – Y Axis min	0	Sets the bottom of the Y axis to 0
AN1 – Style	Progress bar	Sets the control appearance to a progress bar
AN2, AN3 & PC3 – As AN1.		
CCP1 – Show title	Yes	Shows the control title 'CCP1' next to the control

Control - Property	Value	Meaning
CCP1 – Title front size	15	Sets the title text size to 15
CCP1 – Style	Slider	Requests a slider control
CCP2 & CCP3 – As CCP1.		
PA3 – Style	Regular list	Sets the control style as a list box
DT – Style	Inline control(s)	Sets the control to be a date-time picker control

10. Reprogram the DARC-II with the configuration you have just specified, i.e. repeat the steps from step 9 in the *Initializing the Evaluation Application*.

This example covers most of the capabilities of the DARC-II module. Now that you are familiar with the way FlexiPanel Designer works, can build upon the above steps to develop your application. If needed, consult the FlexiPanel Designer documentation, to know more about the different control and I/O capabilities,

Customization

The DARC-II module is capable of creating user interfaces, setting up I/O and connecting I/O pins to the controls. In some commercial cases this is not sufficient and you will wish to customize the DARC module. For example, you may wish to calibrate analog inputs so that they read out in a meaningful range rather than the values 0 to 1023.

To make customization possible, we have made the C source code freely available for you to customize. To do this you will need to know how to program microcontrollers in C and also be familiar with Microchip Technology's MPLAB development environment. Information for customizing the DARC-II is given in the ToothPIC documentation available from www.FlexiPanel.com.

Since many customization requirements are relatively simple, we offer a paid-for customization service to commercial developers who are not familiar with programming in the MPLAB development environment. Please contact us for details.

Mechanical Data

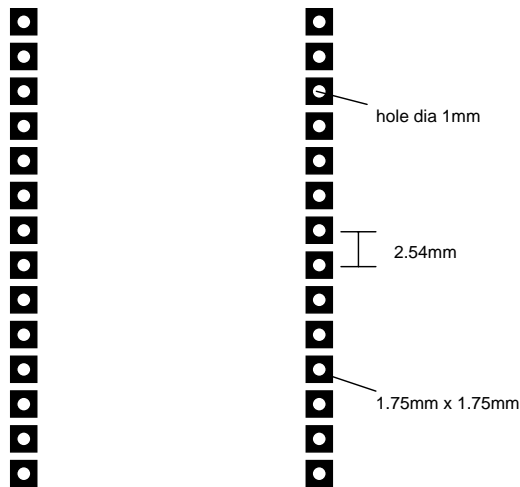
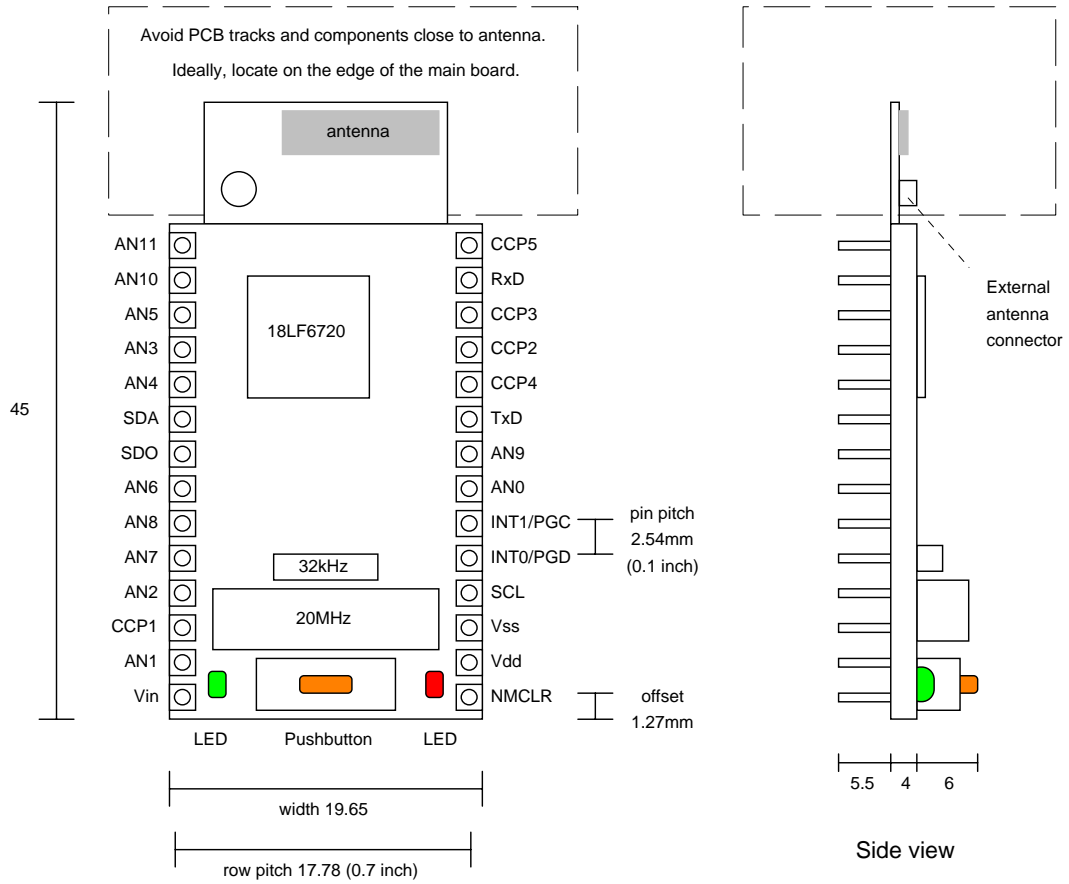

Main board PCB pad layout

Dimensions in mm unless otherwise stated

Notes: Ensure the area where the module is mounted has a solid ground plane. To remove the module from an IC socket or breadboard, lever it out using a screwdriver against the pin headers at the sides. Levering from either end may damage components.

Technical Specifications

Max operating temperature	-20°C to +75 °C
Max storage temperature	-30°C to +85 °C
Dimensions L x W x H	45mm x 20mm x 10mm excluding pins

Electrical

Supply Voltage (unregulated)	5V to 10V
Supply Voltage (regulated)	4.5V to 5.5V
Peak power requirement excluding draw on I/O pins	270mA
Maximum current on any I/O pin	25mA
Maximum total current on all I/O pins	200mA
Max voltage on I/O pins	-0.5V to +5.5V

Radio

Max RF output power	Class I = 100mW = +20dBm
RF frequency range	2402MHz to 2480MHz
RF channels / frequency hop rate	79 / 1600 Hz
Range	100m nominal
Communication latency, μ P to μ P	30ms to 50ms
Maximum data rate	50-90 Kbaud depending on conditions
Pairing method	Unit key pairing

FCC, CE and IC modular approval

The radio has 'modular approval' for USA, Canada and certain European countries, provided the existing integral antenna is used. The CE mark on the module indicates that it does not require further R&TTE certification. The exterior of the product should be marked as follows:

Contains Transmitter Module FCC ID: CWTUGPZ1 Contains Transmitter Module IC: 1788F-UGPZ1

Ordering Contact Details

DARC-II is manufactured and distributed by



R F Solutions Ltd
Unit 21, Cliffe Industrial Estate,
Lewes, E. Sussex BN8 6JL, United Kingdom
email : sales@rfsolutions.co.uk
<http://www.rfsolutions.co.uk>
Tel: +44 (0)1273 898 000, Fax: +44 (0)1273 480 661

Technical Information and Customization Contact Details

DARC-II is owned and designed by FlexiPanel Ltd:



FlexiPanel Ltd
Suite 120, Westbourne Studios
242 Acklam Road
London W10 5JJ, United Kingdom
Tel +44 (0) 20 7524 7774
email: support@flexipanel.com